

Snap Disc Thermostats SN-8A, SN-8C, SN-8M

Description:

A snap-acting bimetal disc serves as the actuating element in these rugged, precision thermostats. As the temperature reaches the tamper-proof predetermined set point, the disc snaps to provide rapid, positive contact action minimizing radio frequency interference and ensuring high reliability. These thermostats are individually calibrated and tested to meet both thermal and electrical characteristics. Resistance to vibration and harsh environments are additional features. Many terminations and mounting assemblies are available to permit great flexibility in installation.

Features

- As per international design
- High current capacity
- Temperature control and overheating protection
- High thermal sensitivity
- Available in plastic and ceramic base
- Automatic, one shot, manual reset modes available
- Variety of mounting brackets and terminals available
- Long contact life

Applications:

- Rice Cookers
- Water Heaters
- Vacuum Cleaners
- Coffee Makers
- Microwave Ovens
- Dish Dryers



Selection Code:

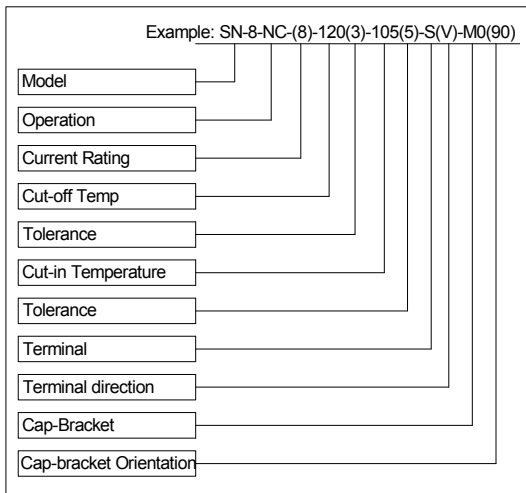

Specifications:

Rated Current	4A, 8A, 16A, 25A
Rated Voltage	230 VAC
Operating Cycles	100,000 cycles
Maximum Temperature	160°C
Operating Range	50°C - 230°C
Setting Tolerance	+/- 3%
Differential	10-25°C
Base Material	PPS, Ceramic
Terminals	4.8, 6.3 mm
Mounting Brackets	Surface mount, Air stream, 4mm, 5mm

Line Diagram:

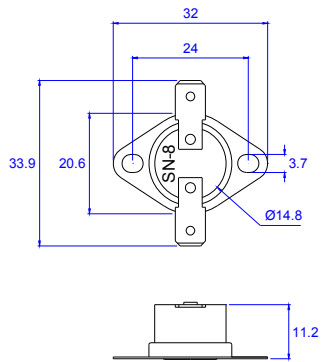

Models:

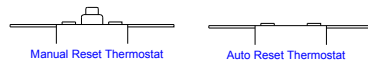

Terminals:

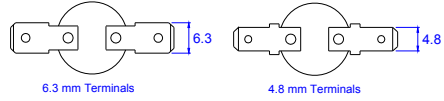

Terminal angle:

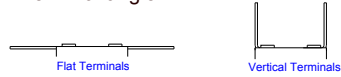

Mounting Brackets:

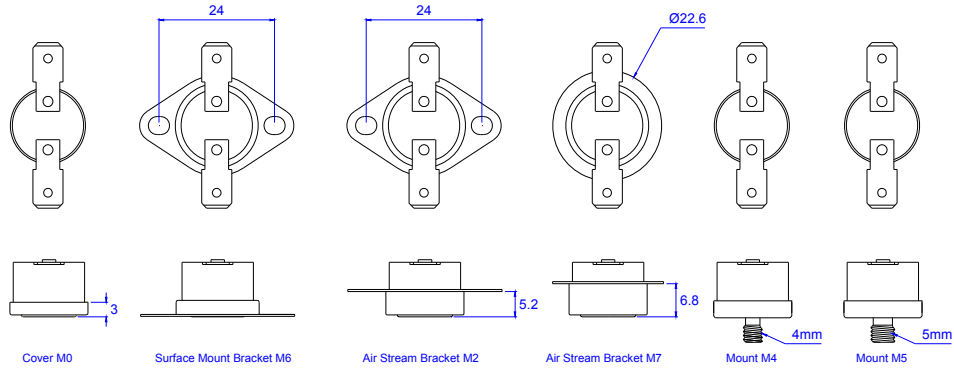

Terminal Bracket Orientation:

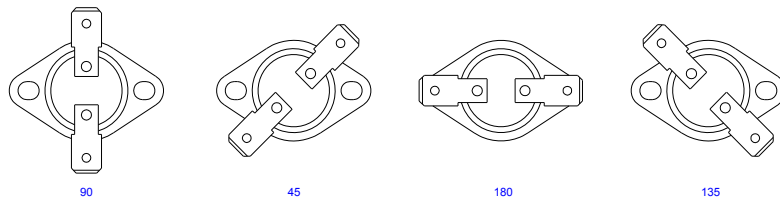

UTILITI CONTROLS

9, Mercantile, Above HSBC Bank, Gidwani Road, Chembur, Mumbai 400 074, INDIA.

Phone: 91-22-2520-6836 • Fax: 91-22-2520-0109

E-mail: utilt@mtnl.net.in, utiliticontrols@gmail.com

These instructions do not purport to cover all the details or variations in the equipment described, nor do they provide for every possible contingency to be met in connection with installation, operation and maintenance. All specifications are subject to change without notice. www.utiliticontrols.com
Should further information be desired or should particular problems arise which are not covered sufficiently for the purchaser's purposes, the matter should be referred to Utiliti Controls, Mumbai.